

DH-PFA139

Water-proof Junction Box



Features

- Aesthetic design
- Material: aluminum
- Water-proof junction box

Technical Specifications

Model	DH-PFA139
General	
Material	Aluminum
Dimension	Φ108.0mmx28.5mm (Φ4.25"x1.12")
Inch Thread	M20(G1/2")
Load Bearing	1.0kg(2.2lb)
Weight	0.16kg(0.35lb)
Color	White
Operating Temperature	-40°C~+60°C (-40°F~+140°F)
Humidity	<90% RH
Applicable Model	Please see "Accessory Selection"

Order Information

Type	Part Number	Description
Camera Mount	DH-PFA139	Water-proof junction box
	PFA139	Water-proof junction box

Dimensions (mm/inch)

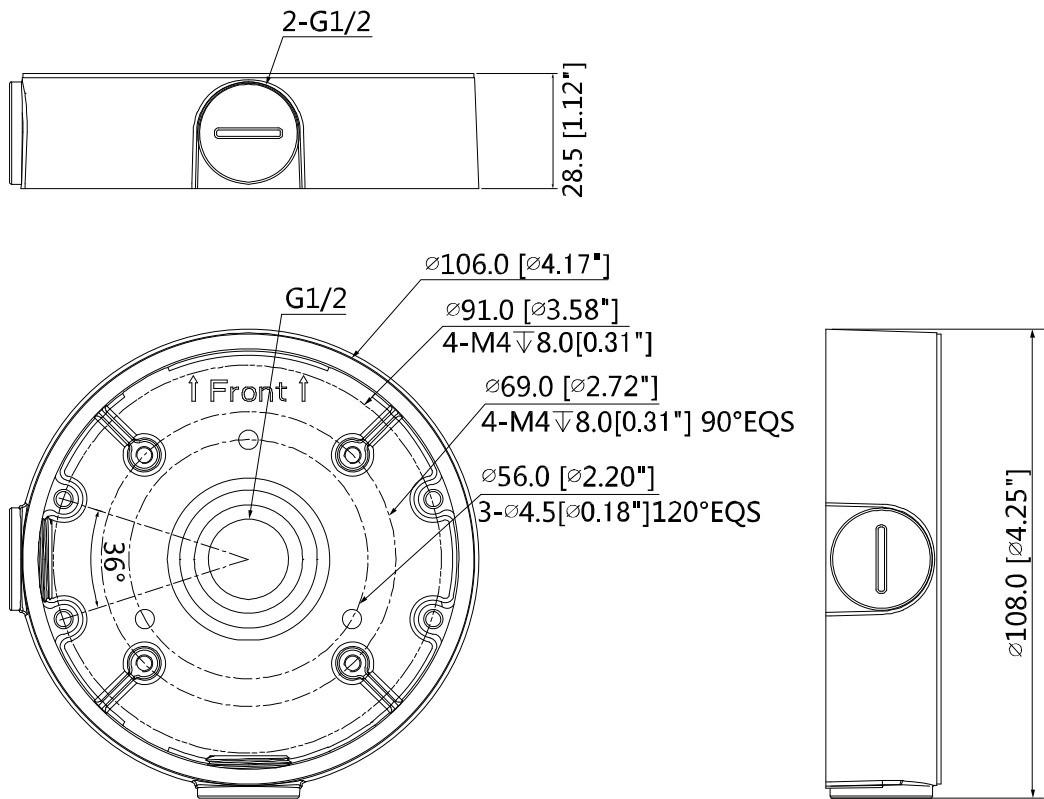

Application

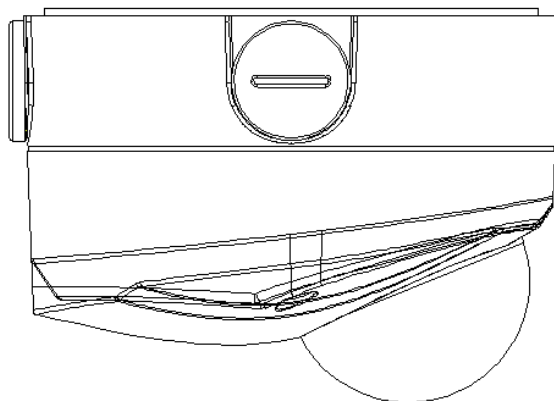

Package Information

- Water-proof junction box *1
- M4x10 screw *4
- ST4x25 screw *3
- Plastic anchor: 3
- Water joint *1
- Wrench *1